

REV	RELEASE	DESCRIPTION	APPR	DATE
A	NEW	INITIAL RELEASE	PD	9/27/19

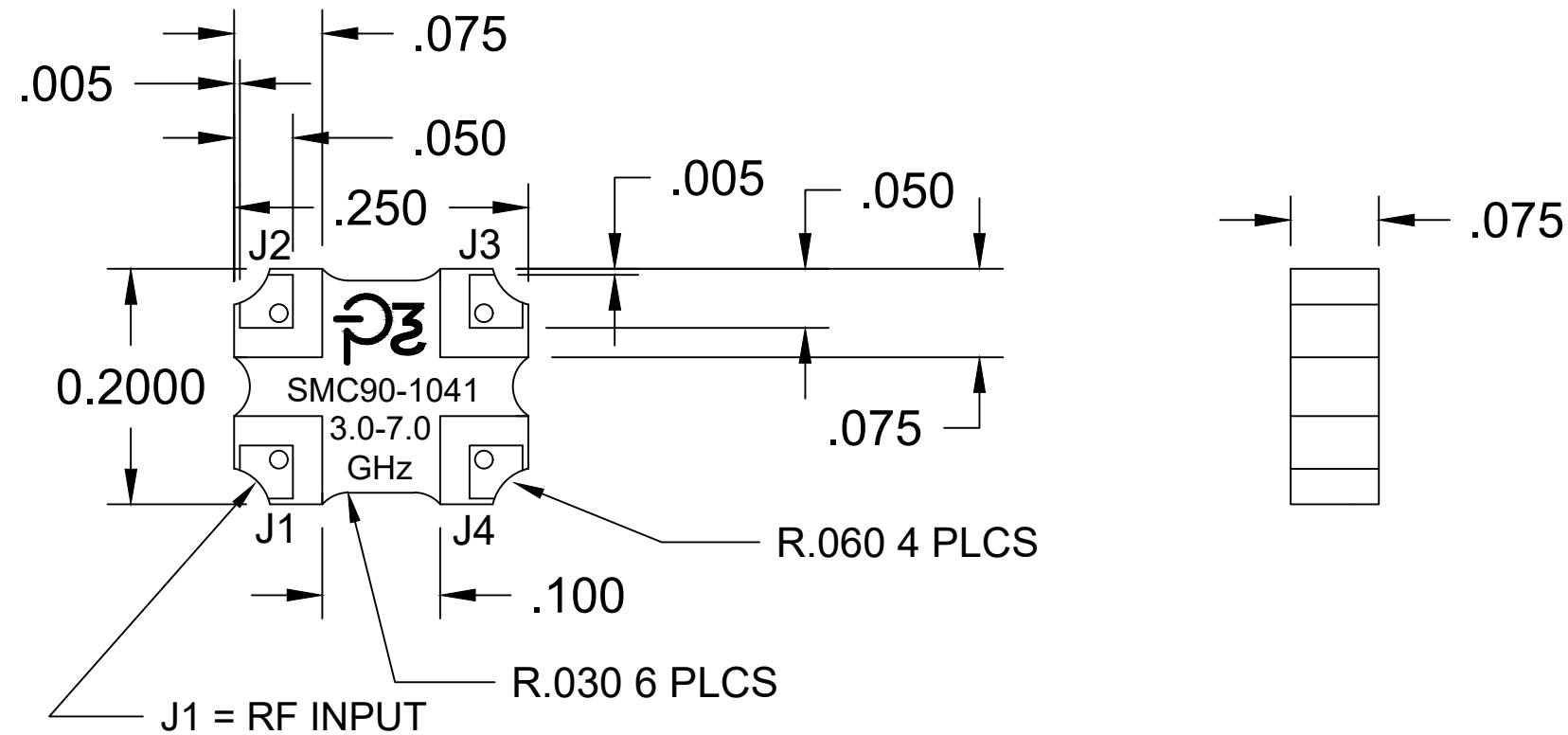

SPECIFICATIONS:

Frequency: 3000-7000 MHz.
 Power: 50 Watts CW
 Insertion Loss: 0.45 dB Max.
 Isolation: 23 dB Min.
 Phase Bal.: 90° ±2.0° Max.
 VSWR: 1.25 Max..
 Amplitude Bal.: ±1.0 dB Max.
 Oper. Temp.: -55° to +85°C

MECHANICAL:

Board Material: PTFE
 Finish: Emmersion Tin Plate



PORT CONFIGURATION

PORTS	J1	J2	J3	J4
J1	--	0°	-90°	ISO
J2	0°	--	ISO	-90°
J3	-90°	ISO	--	0°
J4	ISO	-90°	0°	--



**PREFERRED
 POWER PRODUCTS**
 PALM CITY, FLORIDA 34990

UNLESS OTHERWISE SPECIFIED
 ALL DIMENSIONS ARE IN INCHES

TOLERANCES:

DECIMALS	ANGULAR
.X ± .1	± .5°
.XX ± .01	
.XXX ± .005	

THIS DRAWING AND ALL CONTENTS
 HEREIN, ARE THE SOLE, PROPRIETARY
 PROPERTY OF PREFERRED POWER
 PRODUCTS, LLC AND MAY NOT BE USED,
 REPRODUCED OR DISCLOSED WITHOUT
 EXPRESSED WRITTEN CONSENT.

PART NO. SMC90-1041			
HYBRID COUPLER, SMT, 90 DEG. 3000-7000 MHz. 50 WATT			
CHECKED	PD	9/27/19	APPROVED PD 9/27/19
DRAWN	PD	9/27/19	ENGINEER PD 9/27/19
CAGE CODE	7W5T7	SCALE	1:1 SHEET 1 OF 1